



Operating instructions

Series S302

Numerical large size displays
with Modbus/TCP interface

1 Contact

www.siebert-group.com

GERMANY

Siebert Industrieelektronik GmbH
Siebertstrasse, D-66571 Eppelborn
P.O. Box 11 30, D-66565 Eppelborn
Phone +49 (0)6806 980-0, Fax +49 (0)6806 980-999
email info.de@siebert-group.com

AUSTRIA

Siebert Österreich GmbH
Mooslackengasse 17. A-1190 Wien
Phone +43 (0)1 890 63 86-0, Fax +43 (0)14 890 63 86-99
email info.at@siebert-group.com

FRANCE

Siebert France Sarl
4 rue de l'Abbé Louis Verdet, F-57200 Sarreguemines
P.O. Box 90 334, F-57203 Sarreguemines Cédex
Phone +33 (0)3 87 98 63 68, Fax +33 (0)3 87 98 63 94
email info.fr@siebert-group.com

THE NETHERLANDS

Siebert Nederland B.V.
Jadedreef 26, NL-7828 BH Emmen
Phone +31 (0)591-633444, Fax +31 (0)591-633125
email info.nl@siebert-group.com

SWITZERLAND

Siebert AG
Bützbergstrasse 2, P.O. Box 91, CH-4912 Aarwangen
Phone +41 (0)62 922 18 70, Fax +41 (0)62 922 33 37
email info.ch@siebert-group.com

2 Legal note

© Siebert Industrieelektronik GmbH

This operation manual has been prepared with the utmost care. However, we do not accept any liability for possible errors. We always appreciate your suggestions for improvement, corrections, comments and proposals. Please contact us: editing@siebert-group.com

Siebert[®], LRD[®] and XC-Board[®] are registered trademarks of Siebert Industrieelektronik GmbH. All other product names mentioned herein may be trademarks or registered trademarks of their respective owners.

We reserve the right to make alterations to the technical data and delivery options without notice. - All rights reserved, including the rights of translation. No part of this document may in any form or by any means (print, photocopy, microfilm or any other process) be reproduced or by using electronic systems be processed, copied or distributed without our written permission.

Table of contents

1 Contact	2
2 Legal note	3
3 Safety precautions	6
Important information	6
Safety	6
Intended use.....	6
Mounting and installation.....	6
Grounding.....	7
EMC measures.....	7
Disposal.....	7
4 Unit description	8
Model designation	8
Unit construction.....	8
Principle circuit diagram	9
Central Processing Unit.....	9
DIP switch.....	10
Modbus/TCP interface.....	10
Function inputs	10
Auxiliary voltage	10
Menu display	10
Menu buttons.....	10
Switching output	10
Status indicators	10
Power supply.....	11
5 Configuration	12
MAC address.....	12
Network parameter.....	12
6 Control	13
Function Code	13
Data format.....	13
Start address	13
Data format INTEGER.....	13
Data format ASCII	14
Flashing	15
LED color.....	15
Blanking.....	15
Brightness.....	15

Switching output	15
Time-out	15
Decimal point.....	15
Leading zero suppression	15
Display test	16
Demo operation mode.....	16
Power-on reset	16
Character set.....	16
7 Parametrization	17
Menu.....	17
Menu operation.....	17
Menu table.....	18
8 Technical data	20
Unit properties	20
Max. power consumption	21
Switching output	21
Screw-type terminals	21
Housing colors.....	21
Front frame	22
Ambient conditions	22
Measurements and weights	23

3 Safety precautions



Bus errors may result in personal injury or material damage. Therefore it must be noted that the activation of the menu may cause a bus error.

Important information

Read these operating instructions before starting the unit. They provide you with important information on the use, safety and maintenance of the units. This helps you to protect yourself and prevent damage to the unit.



Information intended to help you to avoid death, bodily harm or considerable damage to property is highlighted by the warning triangle shown here; it is imperative that this information be properly heeded.

The operating instructions are intended for trained professional electricians familiar with the safety standards of electrical technology and industrial electronics.

Store these operating instructions in an appropriate place.

The manufacturer is not liable if the information in these operating instructions is not complied with.

Safety



Components inside the units are energized with electricity during operation. For this reason, mounting and maintenance work may only be performed by professionally-trained personnel while observing the corresponding safety regulations.

The repair and replacement of components and modules may only be carried out by the manufacturer for safety reasons and due to the required compliance with the documented unit properties.

The units do not have a power switch. They are operative as soon as the operating voltage is applied.

Intended use

The units are intended for use in industrial environments. They may only be operated within the limit values stipulated by the technical data.

When configuring, installing, maintaining and testing the units, the safety and accident-prevention regulations relevant to use in each individual case must be complied with.

Trouble-free, safe operation of the units requires proper transport, storage, installation, mounting and careful operation and maintenance of the units.

Mounting and installation

The attachment options for the units were conceived in such a way as to ensure safe, reliable mounting.



The user must ensure that the attachment hardware, the unit carrier and the anchoring at the unit carrier are sufficient to securely support the unit under the given surrounding conditions.

The units are to be mounted in such a way that they can be opened up while mounted. Sufficient space for the cables must be available in the unit near the cable entries.

Sufficient space is to be kept clear around the units to ensure air circulation and to prevent the build-up of heat resulting from use. The relevant information must be heeded in the case of units ventilated by other means.



When the housing fasteners are opened, the front frame of the housing hinges out upward or downward (depending on the unit version) automatically.

Grounding

All devices are equipped with a metal housing. They comply with safety class I and require a protective earth connection. The connecting cable for the operating voltage must contain a protective earth wire of a sufficient cross section (DIN VDE 0106 part 1, DIN VDE 0411 part 1).

EMC measures

The devices comply with the EU Directive 2004/108/EC (EMC Directive) and provide the required interference immunity. Observe the following when connecting the operating voltage and data cables:

Use shielded data cables.

The data and operating voltage cables must be laid separately. They may not be laid together with heavy-current cables or other interference-producing cables.

The cable thickness must be properly assessed (DIN VDE 0100 Part 540).

The cable lengths inside the units are to be kept as short as possible to prevent interference. This applies especially to unshielded operating voltage cables. Shielded cables are also to be kept short due to any interference which might be emitted by the shielding.

Neither excessively long cables nor cable loops may be placed inside the units.

The connection of the cable shielding to the functional ground (PE) must be as short and low-impedance as possible. It should be made directly to the mounting plate over a large area with a conductive clip:

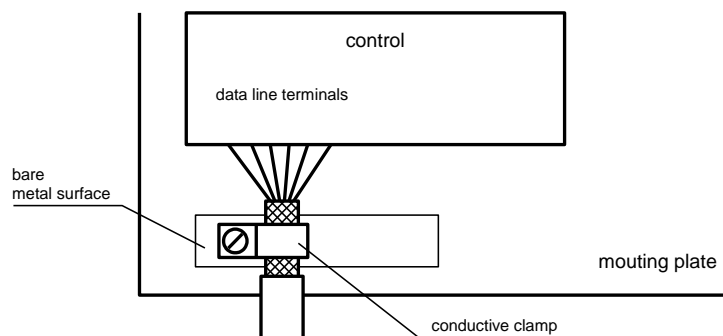

The cable shielding is to be connected at both cable ends. If equipotential bonding currents are expected due to the cable arrangement, electrical isolation is to be performed on one side. In this case, capacitive connection (approx. $0.1\mu\text{F}/600\text{ V AC}$) of the shielding on the isolated side must occur.

Disposal

Units or unit parts which are no longer needed are to be disposed of in accordance with the regulations in effect in your country.

4 Unit description

Model designation

This manual applies to units with the following model designation (x = the 'x's in the model designation indicate the size and design of the units see Chapter 8):

S302-xx/xx/xx-xxx/xx-YT

Unit construction

The following figure shows model type S302-05/10/xx-xxx/xx-xx as example for the other model types. The front frame of the housing is locked with quick-action releases. When opening the unit the front frame hinges downward.

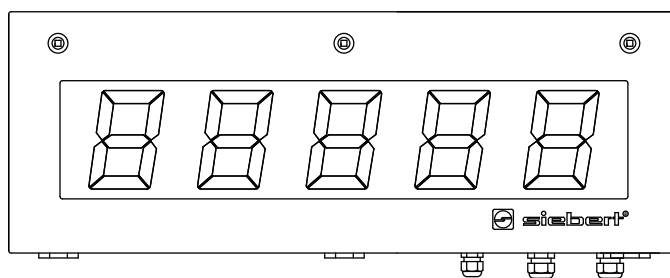

The following figure shows the unit when open.

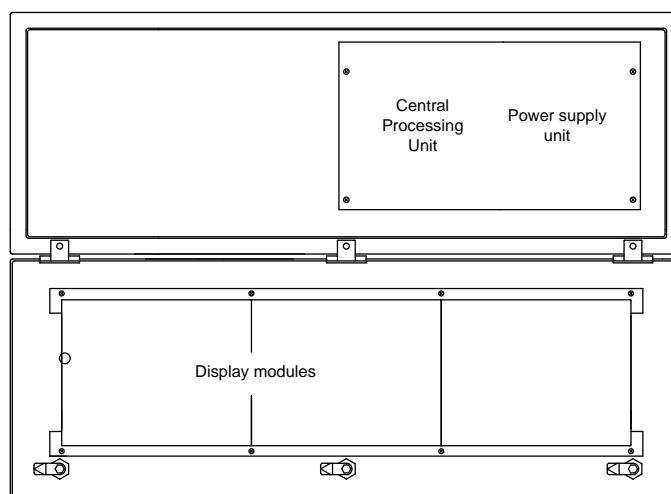

Units with double-sided display show the same information on the front and on the rear side.

Principle circuit diagram

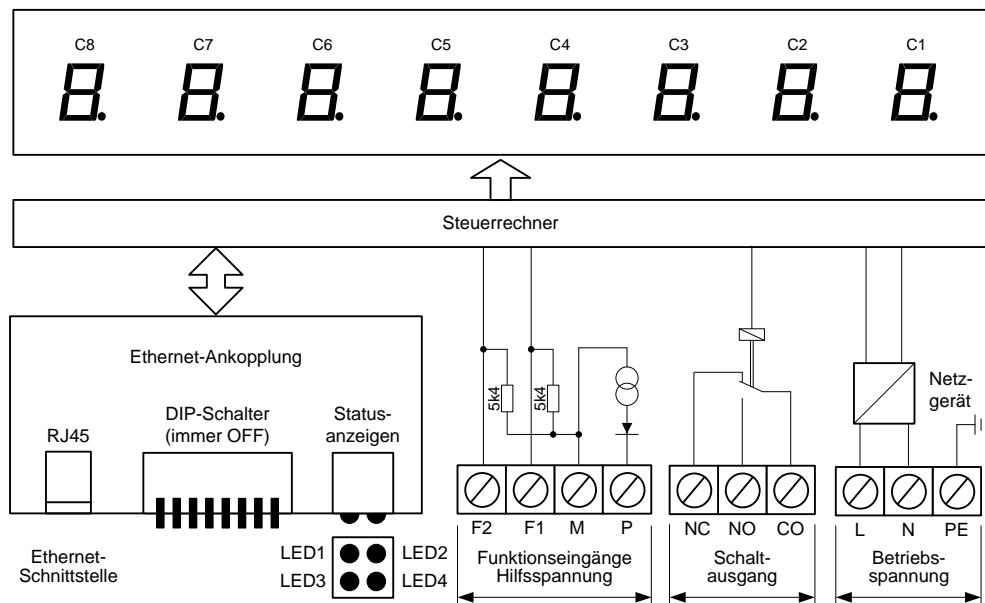

Steuerrechner	Central Processing Unit
Ethernet-Ankopplung	Ethernet coupling
DIP-Schalter	DIP switch
Statusanzeigen	Status indicators
Ethernet-Schnittstelle	Ethernet interface
Funktionseingänge/ Hilfsspannung	Function inputs/ Auxiliary voltage
Schaltausgang	Switching output
Netzgerät	Power supply unit
Betriebsspannung	Power supply

Central Processing Unit

The following figure shows the Central Processing Unit, located in the lower part of the housing.

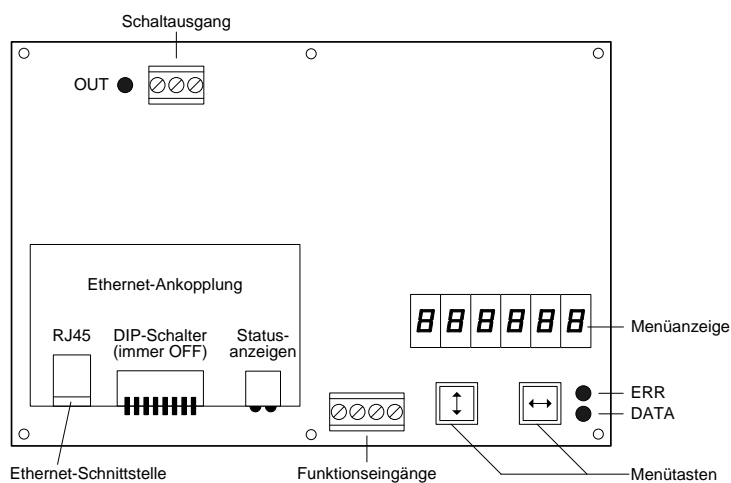

Schaltausgang	Switching output
Ethernet-Ankopplung	Etherent coupling
DIP-Schalter (immer OFF)	DIP switch (always OFF)
Statusanzeigen	Status indicators
Ethernet-Schnittstelle	Ethernet interface
Funktionseingänge	Function inputs
Menütasten	Menu buttons
Menüanzeige	Menu display

DIP switch

The DIP switches must be in OFF position.

Modbus/TCP interface

Die Modbus/TCP interface is located on the RJ45 jack of the Ethernet coupling. It has a galvanic isolation.

Function inputs

The function inputs are located on the screw-type terminal strip of the control computer. They allow reduction in brightness and flashing of the display, independently of commands via the Modbus/TCP interface (see Chapter 6).

Auxiliary voltage

The units supply terminal P with an auxiliary voltage galvanically isolated from the operating voltage (24 V \pm 20%, max. 50 mA, M = reference potential). It can be used for supplying power to the current loop or as H signal for the function inputs.

Menu display

The parameterization of the units is carried out in a menu of the menu display (see Chapter 7). In normal mode, the menu display corresponds to the main display. For devices with more than six positions, *LINE* is shown in the menu display in normal operation.

Menu buttons

The menu buttons are used to control the menu (see Chapter 7).

Switching output

The devices dispose of a switching output (relay) with potential-free make contact (NC, NO, CO).

Status indicators

The status indicators (LED) of the control computer and the Modbus/TCP coupling have the following meaning:

LED1	Data connection (flickering = data traffic)	
LED2	Off	Data speed 10 Mb/s
	Green	Data speed 100 Mb/s
	Red	IP address conflict
LED3	No meaning	
LED4	No meaning	
DATA	Data receipt	

ERR No meaning

OUT Switching output active

Other status information (LED1...LED4) is of no meaning.

Power supply

The screw-type terminals for the power supply are located on the power supply unit in the bottom section of the housing. They have the following designations:

Devices for a power supply 115 V AC or 230 V AC	L, N and PE
Devices for a power supply 24 V DC	+, – and PE

5 Configuration

MAC address

The MAC address of the device can be found on the Modbus/TCP coupling of the control computer (see label). It is needed for commissioning and should be written down on page 2 of this operating manual before the unit is mounted on an inaccessible location.

Network parameter

The network parameters can be set without any external tools in the menu. (see Chapter 7).



Bus errors may result in personal injury or material damage. Therefore it must be noted that the activation of the menu may cause a bus error.

In menu item IP you select between DHCP and static IP address.

The static IP address is to be set in the following menu items:

I.1...I.4	IP address	Factory setting 192.168.127.254
S.1...S.4	Subnet mask	Factory setting 255.255.255.0
G.1...G.4	Gateway	Factory setting 192.168.127.1

6 Control



Bus errors may result in personal injury or material damage. Therefore it must be noted that the activation of the menu may cause a bus error.

Function Code

The devices are Modbus/TCP slaves according to the *Open Modbus/TCP Specification Release 1.0*. They support *function code 16 (0x10) Write Multiple Registers*.

Data format

The data format for the evaluation of Modbus data is set in menu item 1 (see Chapter 7).

Start address

The data is written starting from register address 0x0000.

Data format INTEGER

The data is transmitted with 4 bytes.

Byte 0 contains the formatting of the display and the control of the switching output. The following bytes contain the indicator value in INTEGER format.

	Byte 0	Byte 1	Byte 2	Byte 3
UI16/SI16	7 6 5 4 3 2 1 0 Formatting	7 6 5 4 3 2 1 0 Reserved	7 6 5 4 3 2 1 0 MSB	7 6 5 4 3 2 1 0 LSB
UI24/SI24	7 6 5 4 3 2 1 0 Formatting	7 6 5 4 3 2 1 0 MSB	7 6 5 4 3 2 1 0	7 6 5 4 3 2 1 0 LSB
	: : : : : : : :			
	: : : : : 0 0 0	No decimal point		MSB: Most Significant Byte
	: : : : : 0 0 1	Decimal point digit C2		LSB: Least Significant Byte
	: : : : : 0 1 0	Decimal point digit C3		
	: : : : : 0 1 1	Decimal point digit C4		
	: : : : : 1 0 0	Decimal point digit C5		
	: : : : : 1 0 1	Decimal point digit C6		
	: : : : : 1 1 0	Decimal point digit C7		
	: : : : : 1 1 1	Decimal point digit C8		
	: : : : : :			
	: : : : : 0	Deactivate switching output (Relais off)		
	: : : : : 1	Activate switching output (Relais on)		
	: : : : : :			
	: : : : : 0	Normal brightness		
	: : : : : 1	Reduced brightness (only devices with LED display)		
	: : : : : :			
	: : : : : 0	Flashing off		
	: : : : : 1	Flashing on (only devices with LED display)		
	: : : : : :			
	0 0	Blanking off	Valid for units with monochrome LED display or LRD® display	
	0 1	Blanking on		
	1 0	Reserved		
	: :			
	0 0	LED color red	Valid for units with switchable LED color	
	0 1	LED color green		
	1 0	LED color orange		
	: :			
	1 1	Display test		

Depending on the operation mode chosen there are the following maximum display areas:

UI16	0...65535
SI16	-32768...32767
UI24	0...16777215
SI24	-8388608...8388607

The display shows a □ (overflow) in case of a display overrange or a ◡ (underflow) in case of any display underrange.

Data format ASCII

The data is transmitted using a number of bytes depending on the number of digits of the device.

Byte 0 contains the formatting of the display and the control of the switching output. The following bytes contain the indicator value in ASCII format (C8...C1).

Units with 1 digit S302-x1/xx/xx-xxx/xx-xx	Byte 0 Charact.	Byte 1 C1							
Units with 2 digits S302-x2/xx/xx-xxx/xx-xx	Byte 0 Charact.	Byte 1 C2	Byte 2 C1						
Units with 3 digits S302-x3/xx/xx-xxx/xx-xx	Byte 0 Charact.	Byte 1 C3	Byte 2 C2	Byte 3 C1					
Units with 4 digits S302-x4/xx/xx-xxx/xx-xx	Byte 0 Charact.	Byte 1 C4	Byte 2 C3	Byte 3 C2	Byte 4 C1				
Units with 5 digits S302-x5/xx/xx-xxx/xx-xx	Byte 0 Charact.	Byte 1 C5	Byte 2 C4	Byte 3 C3	Byte 4 C2	Byte 5 C1			
Units with 6 digits S302-x6/xx/xx-xxx/xx-xx	Byte 0 Charact.	Byte 1 C6	Byte 2 C5	Byte 3 C4	Byte 4 C3	Byte 5 C2	Byte 6 C1		
Units with 7 digits S302-x7/xx/xx-xxx/xx-xx	Byte 0 Charact.	Byte 1 C7	Byte 2 C6	Byte 3 C5	Byte 4 C4	Byte 5 C3	Byte 6 C2	Byte 7 C1	
Units with 8 digits S302-x8/xx/xx-xxx/xx-xx	Byte 0 Charact.	Byte 1 C8	Byte 2 C7	Byte 3 C6	Byte 4 C5	Byte 5 C4	Byte 6 C3	Byte 7 C2	Byte 8 C1

Byte 0							
7	6	5	4	3	2	1	0
:	:	:	:	:	:	:	:
:	:	:	:	0	0	0	No decimal point
:	:	:	:	0	0	1	Decimal point digit C2
:	:	:	:	0	1	0	Decimal point digit C3
:	:	:	:	0	1	1	Decimal point digit C4
:	:	:	:	1	0	0	Decimal point digit C5
:	:	:	:	1	0	1	Decimal point digit C6
:	:	:	:	1	1	0	Decimal point digit C7
:	:	:	:	1	1	1	Decimal point digit C8
:	:	:	:	:	:	:	:
:	:	:	:	0	:	:	Deactivate switching output (Relais off)
:	:	:	:	1	:	:	Activate switching output (Relais on)
:	:	:	:	:	:	:	:
:	:	:	:	0	:	:	Normal brightness
:	:	:	:	1	:	:	Reduced brightness (only devices with LED display)
:	:	:	:	:	:	:	:
:	:	:	:	0	:	:	Flashing off
:	:	:	:	1	:	:	Flashing on (only devices with LED display)
:	:	:	:	:	:	:	:
0	0	:	:	:	:	:	Blanking off
0	1	:	:	:	:	:	Blanking on
1	0	:	:	:	:	:	Reserved
:	:	:	:	:	:	:	:
0	0	:	:	:	:	:	LED color red
0	1	:	:	:	:	:	LED color green
1	0	:	:	:	:	:	LED color orange
:	:	:	:	:	:	:	:
1	1	:	:	:	:	:	Display test

Valid for units with monochrome LED display or LRD® display

Valid for units with switchable LED color

Flashing

If in byte 0 bit 5 is set, the whole display flashes.

Flashing of the display can also be activated by application of the H signal to function input F1 (priority over bit 5 in byte 0).

For devices with LRD[®] display flashing is not possible.

LED color

The LED color can be defined in byte 0 with bit 7 and bit 6 (only for units with switchable LED color).

Blanking

If in byte 0 bit 6 is set, the display will be blank (priority over flashing; not possible for devices with switchable LED color).

Brightness

If in byte 0 bit 4 is set the brightness of the display will be reduced

The brightness can be reduced with an H signal on function input F2 (Priority over bit 4 in byte 0).

For units provided with a LRD[®] display brightness reduction is not possible.

Switching output

The units have a switching output (relay) with a potential free changeover contact (NC, NO, CO).

If in menu point r the setting is OFF the switching output can be activated by setting bit 3 in byte 0.

When setting A1, A2 or A4 in menu item r, the switching output automatically gives a wiping pulse with a duration of 1, 2 or 4 seconds with every valid telegram.

The wipe function is suitable p. e. for controlling optical and acoustic signal generators.

When the switching output is active the status indicator OUT of the Central Processing Unit is lightening.

Time-out

In menu item t, it is possible to set whether a time-out occurs, and if so, after what time. Time-out means that minus signs appear on the display if the device has not received a data telegram after a defined time.

Decimal point

You can set a decimal point in menu item A.

The decimal point can also be controlled by setting the bits 2...0 in byte 0. In menu item A, the setting 0 (no fixed decimal point) is to be selected.

A decimal point set in menu item A has priority.

Units with LRD[®] display have no decimal points.

Leading zero suppression

In menu item C it is set if leading zeros are to be displayed or suppressed. If leading zeros are to be blanked out for devices with LRD[®] display and fixed decimal point (p. e. with self-adhesive film) its position has to set in menu item A.

Display test

In menu item F, you can set whether a display test is to be performed after the operating voltage is applied.

The display test can also be activated by setting bits 7 and 6 in byte 0.

The display test has priority over flashing and blanking.

Demo operation mode

If the setting *PLRY* is selected in menu item F, random characters are displayed. In this case, it is impossible to control the unit.

Power-on reset

After power-on, minus signs are displayed to signalize that the unit is ready for operation. If a display test has been preselected in menu item F, it will run beforehand.

Character set

20/2B	2D	30	31	32	33	34	35	36	37	38	39	2C/2E
	-	0	1	2	3	4	5	6	7	8	9	.
41/61	42/62	43	44/64	45/65	46/66	47/67	48	49	4A/6A	4C/6C	50/70	55
A	b	C	d	E	F	G	H	I	J	L	P	U
59/79	5F	63	68	69	4E/6E	4F/6F	52/72	54/74	75	58/78	other	
y	-	c	h	i	n	o	r	t	u	v	w	x

7 Parametrization

Menu

The parameterization of the devices is carried out in a menu in the menu display.



Bus errors may result in personal injury or material damage. Therefore it must be noted that the activation of the menu may cause a bus error.

Menu operation

To start the menu, press both menu buttons simultaneously (approx. 1 sec.) until the first menu item appears in the menu display. It is now possible to navigate in the menu as follows:

Next menu item	Shortly press key [↕]
Page menu items forward	Press key [↕] long
Previous menu item	Double-click on key [↕]
Page menu items backward	Double-click on key [↕] and keep it pressed
Next setting	Shortly press key [↔]
Page settings forward	Press key [↔] long
Previous setting	Double-click on key [↔]
Page setting backward	Double-click on key [↔] and keep it pressed

To exit the menu shortly press the key [↕] in menu item U. Depending on the setting in menu item U the settings made are either saved (set) or not saved (escape) or the factory settings are reset (default).

Canceling the menu without saving the settings made is possible by pressing both menu buttons simultaneously (approx. 1 sec.). It will occur automatically if 60 seconds pass without a menu button being pressed.

Once the menu is closed, the device behaves in the same manner as when the operating voltage was applied.

In the menu mode the character Ξ appears in the main display. Control of the display is not possible in menu mode.

Menu table

The menu items are displayed in the following menu table. The factory settings are marked with an *. Individual menu items or settings can be suppressed in another menu item, depending on the unit version or setting.

Menu item	Settings	Display
1 Data format	Unsigned Integer 16 Bit*	1 0 1 16
	Signed Integer 16 Bit	1 5 1 16
	Unsigned Integer 24 Bit	1 0 1 24
	Signed Integer 24 Bit	1 5 1 24
	ASCII	1 RSC
IP IP address	Static IP address	IP StAtE
	DHCP*	IP dHCP
I.1 IP address Byte 1 (xxx.-----)	0	1.1 0
	↓ 192*	↓
	255	1.1 255
I.2 IP address Byte 2 (---.xxx.-----)	0	1.2 0
	↓ 168*	↓
	255	1.2 255
I.3 IP address Byte 3 (----.xxx.---	0	1.3 0
	↓ 127*	↓
	255	1.3 255
I.4 IP address Byte 4 (-----xxx)	1	1.4 1
	↓ 254*	↓
	254	1.4 254
S.1 Subnet mask Byte 1 (xxx.-----)	0	5.1 0
	↓ 255*	↓
	255	5.1 255
S.2 Subnet mask Byte 2 (---.xxx.-----)	0	5.2 0
	↓ 255*	↓
	255	5.2 255
S.3 Subnet mask Byte 3 (----.xxx.---	0	5.3 0
	↓ 255*	↓
	255	5.3 255
S.4 Subnet mask Byte 4 (-----xxx)	0	5.4 0
	↓ 0*	↓
	255	5.4 255
G.1 Gateway Byte 1 (xxx.-----)	0	6.1 0
	↓ 192*	↓
	255	6.1 255
G.2 Gateway Byte 2 (---.xxx.-----)	0	6.2 0
	↓ 168*	↓
	255	6.2 255
G.3 Gateway Byte 3 (----.xxx.---	0	6.3 0
	↓ 127*	↓
	255	6.3 255

G.4	Gateway Byte 4 (-----xxx)	1	E4	1
		↓	1*	↓
		254	E4	254
r	Switching output	No wiping pulse*	r	OFF
		Wiping pulse 1 sec.	r	1
		Wiping pulse 2 sec.	r	2
		Wiping pulse 4 sec.	r	4
t	Time-out	No time-out*	t	0
		Time-out after 2 sec.	t	2
		Time-out after 4 sec.	t	4
		Time-out after 8 sec.	t	8
		Time-out after 16 sec.	t	16
		Time-out after 32 sec.	t	32
		Time-out after 64 sec.	t	64
		Time-out after 128 sec.	t	128
A	Decimal point	No decimal point*	A	0
		Decimal point digit C1	A	1
		Decimal point digit C2	A	2
		↓	↓	
		Decimal point digit C8	A	8
C	Leading zeros	Leading zeros not displayed*	C	00
		Leading zeros displayed	C	0000
F	Display test	No display test at power-on*	F	----
		Display test at power-on	F	BBBB
		Demo operation mode	F	PLAY
U	Save	Save parameters* (Set)	U	SEt
		Not saving parameters (Escape)	U	ESC
		Restore to factory settings (Default)	U	DEF

8 Technical data

Unit properties

The model designation is structured as follows:

S302	-	<input type="text"/>	/	<input type="text"/>	/	<input type="text"/>	-	<input type="text"/>	/	<input type="text"/>	-	<input type="text"/>
No dimension symbol	0	:	:	:	:	:	:	:	:	:	:	:
Dimension symbol	F	:	:	:	:	:	:	:	:	:	:	:
1 Digit	1	:	:	:	:	:	:	:	:	:	:	:
2 Digits	2	:	:	:	:	:	:	:	:	:	:	:
↓	↓	:	:	:	:	:	:	:	:	:	:	:
8 Digits	8	:	:	:	:	:	:	:	:	:	:	:
Character height 25 mm	0 3	:	:	:	:	:	:	:	:	:	:	:
Character height 57 mm	0 6	:	:	:	:	:	:	:	:	:	:	:
Character height 100 mm	1 0	:	:	:	:	:	:	:	:	:	:	:
Character height 160 mm	1 6	:	:	:	:	:	:	:	:	:	:	:
Character height 250 mm	2 5	:	:	:	:	:	:	:	:	:	:	:
LED Standard	0	:	:	:	:	:	:	:	:	:	:	:
LED, SMD technology		:	:	:	:	:	:	:	:	:	:	:
LED for outdoor use	2	:	:	:	:	:	:	:	:	:	:	:
LRD®	4	:	:	:	:	:	:	:	:	:	:	:
Character color red	R	:	:	:	:	:	:	:	:	:	:	:
Character color green	G	:	:	:	:	:	:	:	:	:	:	:
Character color white	W	:	:	:	:	:	:	:	:	:	:	:
Character color red/green/orange switchable	M	:	:	:	:	:	:	:	:	:	:	:
Display readable on one side	1	:	:	:	:	:	:	:	:	:	:	:
Display readable on both sides	2	:	:	:	:	:	:	:	:	:	:	:
Steel sheet housing, coated	0	:	:	:	:	:	:	:	:	:	:	:
Steel sheet housing, bilayer painting	1	:	:	:	:	:	:	:	:	:	:	:
Stainless steel housing V2A, coated	2	:	:	:	:	:	:	:	:	:	:	:
Stainless steel housing V2A, brushed	3	:	:	:	:	:	:	:	:	:	:	:
Stainless steel housing V4A, brushed	5	:	:	:	:	:	:	:	:	:	:	:
Protection type IP54	0	:	:	:	:	:	:	:	:	:	:	:
Protection type IP65	1	:	:	:	:	:	:	:	:	:	:	:
Protection type IP54 with climate adjustment	2	:	:	:	:	:	:	:	:	:	:	:
Protection type IP54 with climate adjustment and heating	4	:	:	:	:	:	:	:	:	:	:	:
Wall mounting, cable entry point from the bottom	0	:	:	:	:	:	:	:	:	:	:	:
Wall mounting, cable entry point from the top	1	:	:	:	:	:	:	:	:	:	:	:
Hanging installation, cable entry point from the bottom	2	:	:	:	:	:	:	:	:	:	:	:
Hanging installation, cable entry point from the top	3	:	:	:	:	:	:	:	:	:	:	:
Wall mounting and hanging installation, cable entry point from the bottom	4	:	:	:	:	:	:	:	:	:	:	:
Wall mounting and hanging installation, cable entry point from the top	5	:	:	:	:	:	:	:	:	:	:	:
Power supply 230 V AC ±15 %, 50 Hz	A	:	:	:	:	:	:	:	:	:	:	:
Power supply 24 V DC ±15 %	B	:	:	:	:	:	:	:	:	:	:	:
Power supply 115 V AC ±15 %, 60 Hz	C	:	:	:	:	:	:	:	:	:	:	:
Interface		:	:	:	:	:	:	:	:	:	x	x

Max. power consumption

Units with one-sided display	[VA] ¹⁾
1 digit	
S302-x1/10/xx-1xx/xx-xx	12 (50)
S302-x1/16/xx-1xx/xx-xx	22 (50)
S302-x1/25/xx-1xx/xx-xx	26
2 digits	
S302-x2/06/xx-1xx/xx-xx	12
S302-x2/10/xx-1xx/xx-xx	15 (50)
S302-x2/16/xx-1xx/xx-xx	37 (50)
S302-x2/25/xx-1xx/xx-xx	46
3 digits	
S302-x3/06/xx-1xx/xx-xx	13
S302-x3/10/xx-1xx/xx-xx	17 (50)
S302-x3/16/xx-1xx/xx-xx	51 (50)
S302-x3/25/xx-1xx/xx-xx	63
4 digits	
S302-x4/06/xx-1xx/xx-xx	14
S302-x4/10/xx-1xx/xx-xx	21 (50)
S302-x4/16/xx-1xx/xx-xx	64 (50)
S302-x4/25/xx-1xx/xx-xx	79
5 digits	
S302-x5/06/xx-1xx/xx-xx	15
S302-x5/10/xx-1xx/xx-xx	23 (50)
S302-x5/16/xx-1xx/xx-xx	77 (50)
S302-x5/25/xx-1xx/xx-xx	96
6 digits	
S302-x6/03/xx-1xx/xx-xx	16
S302-x6/06/xx-1xx/xx-xx	16
S302-x6/10/xx-1xx/xx-xx	26 (50)
S302-x6/16/xx-1xx/xx-xx	91 (50)
S302-x6/25/xx-1xx/xx-xx	113
7 digits	
S302-x7/06/xx-1xx/xx-xx	17
S302-x7/10/xx-1xx/xx-xx	30 (50)
S302-x7/16/xx-1xx/xx-xx	104 (50)
S302-x7/25/xx-1xx/xx-xx	130
8 digits	
S302-x8/06/xx-1xx/xx-xx	18
S302-x8/10/xx-1xx/xx-xx	32 (50)

Units with double-sided display	[VA] ¹⁾
1 digit	
S302-x1/10/xx-2xx/xx-xx	16 (91)
S302-x1/16/xx-2xx/xx-xx	35 (91)
S302-x1/25/xx-2xx/xx-xx	42
2 digits	
S302-x2/06/xx-2xx/xx-xx	15
S302-x2/10/xx-2xx/xx-xx	21 (91)
S302-x2/16/xx-2xx/xx-xx	66 (91)
S302-x2/25/xx-2xx/xx-xx	83
3 digits	
S302-x3/06/xx-2xx/xx-xx	17
S302-x3/10/xx-2xx/xx-xx	26 (91)
S302-x3/16/xx-2xx/xx-xx	92 (91)
S302-x3/25/xx-2xx/xx-xx	116
4 digits	
S302-x4/06/xx-2xx/xx-xx	19
S302-x4/10/xx-2xx/xx-xx	33 (91)
S302-x4/16/xx-2xx/xx-xx	119 (91)
S302-x4/25/xx-2xx/xx-xx	150
5 digits	
S302-x5/06/xx-2xx/xx-xx	21
S302-x5/10/xx-2xx/xx-xx	38 (91)
S302-x5/16/xx-2xx/xx-xx	146 (91)
S302-x5/25/xx-2xx/xx-xx	184
6 digits	
S302-x6/03/xx-2xx/xx-xx	23
S302-x6/06/xx-2xx/xx-xx	23
S302-x6/10/xx-2xx/xx-xx	43 (91)
S302-x6/16/xx-2xx/xx-xx	173 (91)
S302-x6/25/xx-2xx/xx-xx	217
7 digits	
S302-x7/06/xx-2xx/xx-xx	25
S302-x7/10/xx-2xx/xx-xx	51 (91)
S302-x7/16/xx-2xx/xx-xx	200 (91)
S302-x7/25/xx-2xx/xx-xx	250
8 digits	
S302-x8/06/xx-2xx/xx-xx	27
S302-x8/10/xx-2xx/xx-xx	55 (91)

¹⁾ The values given are approximate values. For units with built-in heating, the values for power consumption specified in the table increase by approx. 10 – 100 VA (exact values on request), depending on the unit size.

() Values in parentheses are valid for LRD[®] versions.

The power consumption for the unit version model S302-xx/xx/0x-xxx/xx-xx is also valid for the unit version S302-xx/xx/2x-xxx/xx-xx (LEDs for external use).

Switching output

Maximum switching voltage 30 V AC/DC
Maximum switching current 500 mA (ohmic load)

Screw-type terminals

Control computer Capacity of terminals 0,14...1,5 mm²
Power supply Capacity of terminals 0,2...4 mm²

Housing colors

Case front RAL 5002 ultramarine
Case rear part RAL 7035 light grey

Front frame

S302-xx/xx/xR-xxx/xx-xx	Plastic, tinted red, non-reflective
S302-xx/06/xG-xxx/xx-xx	Plastic, tinted green, non-reflective
S302-xx/10/xG-xxx/xx-xx	Plastic, tinted green, non-reflective
Other model types	Plastic, clear, non-reflective

Ambient conditions

Operating temperature	0...55 °C
Storage temperature	-30...85 °C
Relative humidity	max. 95 % (non-condensing)

Measurements and weights

Units with one-sided display

The following figure shows unit versions S302-04/10/4x-1xx/xx-xx and S302-F3/10/4x-1xx/xx-, representing the other unit versions listed in the following table.

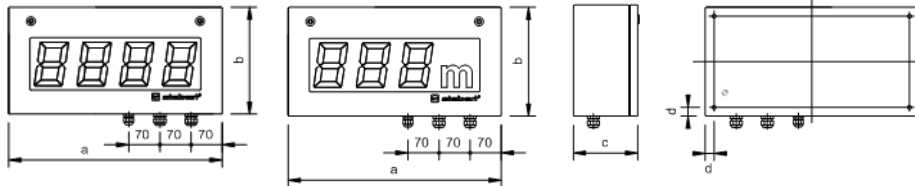

		a [mm]	b [mm]	c [mm]	d [mm]	Ø [mm]	Weight [kg] ¹⁾
1 digit							
S302-01/10/xx-1xx/xx-xx		330 ²⁾	245	110 (145)	16	7	6 (7) ²⁾
S302-01/16/xx-1xx/xx-xx		390	300	110 (145)	20	9	7 (9)
S302-01/25/xx-1xx/xx-xx		570	400	110	20	9	11
2 digits							
1 digit + dimension symbol							
S302-02/06/xx-1xx/xx-xx	-	300 ³⁾	185	110	16	7	5 ³⁾
S302-02/10/xx-1xx/xx-xx	S302-F1/10/xx-1xx/xx-xx	330 ²⁾	245	110 (145)	16	7	6 (7) ²⁾
S302-02/16/xx-1xx/xx-xx	S302-F1/16/xx-1xx/xx-xx	390	300	110 (145)	20	9	7 (9)
S302-02/25/xx-1xx/xx-xx	S302-F1/25/xx-1xx/xx-xx	570	400	110	20	9	11
3 digit							
2 digit + dimension symbol							
S302-03/06/xx-1xx/xx-xx	S302-F2/06/xx-1xx/xx-xx	300 ³⁾	185	110	16	7	5 ³⁾
S302-03/10/xx-1xx/xx-xx	S302-F2/10/xx-1xx/xx-xx	480	245	110 (145)	16	7	8 (9)
S302-03/16/xx-1xx/xx-xx	S302-F2/16/xx-1xx/xx-xx	670	300	110 (145)	20	9	11 (13)
S302-03/25/xx-1xx/xx-xx	S302-F2/25/xx-1xx/xx-xx	1030	400	110	20	9	18
4 digit							
3 digit + dimension symbol							
S302-04/06/xx-1xx/xx-xx	S302-F3/06/xx-1xx/xx-xx	300 ³⁾	185	110	16	7	5 ³⁾
S302-04/10/xx-1xx/xx-xx	S302-F3/10/xx-1xx/xx-xx	480	245	110 (145)	16	7	8 (9)
S302-04/16/xx-1xx/xx-xx	S302-F3/16/xx-1xx/xx-xx	670	300	110 (145)	20	9	11 (13)
S302-04/25/xx-1xx/xx-xx	S302-F3/25/xx-1xx/xx-xx	1030	400	110	20	9	18
5 digit							
4 digit + dimension symbol							
S302-05/03/xx-1xx/xx-xx	-	300 ³⁾	185	110	16	7	5 ³⁾
S302-05/06/xx-1xx/xx-xx	S302-F4/06/xx-1xx/xx-xx	400	185	110	16	7	6
S302-05/10/xx-1xx/xx-xx	S302-F4/10/xx-1xx/xx-xx	680	245	110 (145)	16	7	10 (12)
S302-05/16/xx-1xx/xx-xx	S302-F4/16/xx-1xx/xx-xx	960	300	110 (145)	20	9	14 (17)
S302-05/25/xx-1xx/xx-xx	S302-F4/25/xx-1xx/xx-xx	1500	400	110	20	9	24
6 digit							
5 digit + dimension symbol							
S302-06/03/xx-1xx/xx-xx	S302-F5/03/xx-1xx/xx-xx	300 ³⁾	185	110	16	7	5 ³⁾
S302-06/06/xx-1xx/xx-xx	S302-F5/06/xx-1xx/xx-xx	400	185	110	16	7	6
S302-06/10/xx-1xx/xx-xx	S302-F5/10/xx-1xx/xx-xx	680	245	110 (145)	16	7	10 (12)
S302-06/16/xx-1xx/xx-xx	S302-F5/16/xx-1xx/xx-xx	960	300	110 (145)	20	9	14 (17)
S302-06/25/xx-1xx/xx-xx	S302-F5/25/xx-1xx/xx-xx	1500	400	110	20	9	24
7 digit							
6 digit + dimension symbol							
-	S302-F6/03/xx-1xx/xx-xx	300 ³⁾	185	110	16	7	5 ³⁾
S302-07/06/xx-1xx/xx-xx	S302-F6/06/xx-1xx/xx-xx	510	185	110	16	7	7
S302-07/10/xx-1xx/xx-xx	S302-F6/10/xx-1xx/xx-xx	870	245	110 (145)	16	7	12 (14)
S302-07/16/xx-1xx/xx-xx	S302-F6/16/xx-1xx/xx-xx	1100	300	110 (145)	20	9	16 (20)
S302-07/25/xx-1xx/xx-xx	S302-F6/25/xx-1xx/xx-xx	1730	400	110	20	9	28
8 digit							
7 digit + dimension symbol							
S302-08/06/xx-1xx/xx-xx	S302-F7/06/xx-1xx/xx-xx	510	185	110	32	7	7
S302-08/10/xx-1xx/xx-xx	S302-F7/10/xx-1xx/xx-xx	870	245	110 (145)	32	7	12 (14)

¹⁾ The figures shown for weight are approximate.

²⁾ Units with Profibus interface: a = 480 mm, Weight = 8 (9) kg

³⁾ Units with Profibus interface or integrated heating: a = 400 mm, Weight = 6 kg;
Units with Profibus interface and integrated heating: a = 510 mm, Weight = 7 kg

() Values in round brackets are valid for LRD[®] versions.

Units with double-sided display

The following figure shows unit versions S302-04/10/4x-2xx/xx-xx and S302-F3/10/4x-2xx/xx-, representing the other unit versions listed in the following table.

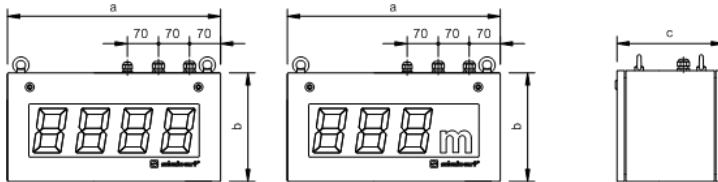

Units with character height of 25 mm (S302-xx/03/xx-2xx/xx-xx) and 57 mm (S302-xx/06/xx-2xx/xx-xx) are provided with 2 eyes instead of 4.

		a [mm]	b [mm]	c [mm]	Weight [kg] ¹⁾
1 digit					
S302-01/10/xx-2xx/xx-xx		330 ²⁾	245	170 (240)	9 (11) ²⁾
S302-01/16/xx-2xx/xx-xx		390	300	170 (240)	11 (12)
S302-01/25/xx-2xx/xx-xx		570	400	170	17
2 digit	1 digit + dimension symbol				
S302-02/06/xx-2xx/xx-xx	-	300 ³⁾	185	170	7 ³⁾
S302-02/10/xx-2xx/xx-xx	S302-F1/10/xx-2xx/xx-xx	330 ²⁾	245	170 (240)	9 (9) ²⁾
S302-02/16/xx-2xx/xx-xx	S302-F1/16/xx-2xx/xx-xx	390	300	170 (240)	11 (11)
S302-02/25/xx-2xx/xx-xx	S302-F1/25/xx-2xx/xx-xx	570	400	170	17
3 digit	2 digit + dimension symbol				
S302-03/06/xx-2xx/xx-xx	S302-F2/06/xx-2xx/xx-xx	300 ³⁾	185	170	7 ³⁾
S302-03/10/xx-2xx/xx-xx	S302-F2/10/xx-2xx/xx-xx	480	245	170 (240)	12 (15)
S302-03/16/xx-2xx/xx-xx	S302-F2/16/xx-2xx/xx-xx	670	300	170 (240)	17 (19)
S302-03/25/xx-2xx/xx-xx	S302-F2/25/xx-2xx/xx-xx	1030	400	170	27
4 digit	3 digit + dimension symbol				
S302-04/06/xx-2xx/xx-xx	S302-F3/06/xx-2xx/xx-xx	300 ³⁾	185	170	7 ³⁾
S302-04/10/xx-2xx/xx-xx	S302-F3/10/xx-2xx/xx-xx	480	245	170 (240)	12 (15)
S302-04/16/xx-2xx/xx-xx	S302-F3/16/xx-2xx/xx-xx	670	300	170 (240)	17 (19)
S302-04/25/xx-2xx/xx-xx	S302-F3/25/xx-2xx/xx-xx	1030	400	170	27
5 digit	4 digit + dimension symbol				
S302-05/03/xx-2xx/xx-xx	-	300 ³⁾	185	170	7 ³⁾
S302-05/06/xx-2xx/xx-xx	S302-F4/06/xx-2xx/xx-xx	400	185	170	8
S302-05/10/xx-2xx/xx-xx	S302-F4/10/xx-2xx/xx-xx	680	245	170 (240)	15 (19)
S302-05/16/xx-2xx/xx-xx	S302-F4/16/xx-2xx/xx-xx	960	300	170 (240)	21 (26)
S302-05/25/xx-2xx/xx-xx	S302-F4/25/xx-2xx/xx-xx	1500	400	170	36
6 digit	5 digit + dimension symbol				
S302-06/03/xx-2xx/xx-xx	S302-F5/03/xx-2xx/xx-xx	300 ³⁾	185	170	7 ³⁾
S302-06/06/xx-2xx/xx-xx	S302-F5/06/xx-2xx/xx-xx	400	185	170	8
S302-06/10/xx-2xx/xx-xx	S302-F5/10/xx-2xx/xx-xx	680	245	170 (240)	15 (19)
S302-06/16/xx-2xx/xx-xx	S302-F5/16/xx-2xx/xx-xx	960	300	170 (240)	21 (27)
S302-06/25/xx-2xx/xx-xx	S302-F5/25/xx-2xx/xx-xx	1500	400	170	36
7 digit	6 digit + dimension symbol				
-	S302-F6/03/xx-2xx/xx-xx	300 ³⁾	185	170	7 ³⁾
S302-07/06/xx-2xx/xx-xx	S302-F6/06/xx-2xx/xx-xx	510	185	170	9
S302-07/10/xx-2xx/xx-xx	S302-F6/10/xx-2xx/xx-xx	870	245	170 (240)	18 (23)
S302-07/16/xx-2xx/xx-xx	S302-F6/16/xx-2xx/xx-xx	1100	300	170 (240)	24 (29)
S302-07/25/xx-2xx/xx-xx	S302-F6/25/xx-2xx/xx-xx	1730	400	170	42
8 digit	7 digit + dimension symbol				
S302-08/06/xx-2xx/xx-xx	S302-F7/06/xx-2xx/xx-xx	510	185	170	9
S302-08/10/xx-2xx/xx-xx	S302-F7/10/xx-2xx/xx-xx	870	245	170 (240)	18 (23)

¹⁾ The figures shown for weight are approximate.

²⁾ Units with Profibus interface: a = 480 mm, Weight = 12 (15) kg

³⁾ Units with Profibus interface or integrated heating: a = 400 mm, Weight = 8 kg;
Units with Profibus interface and integrated heating: a = 510 mm, Weight = 9 kg

() Values in round brackets are valid for LRD[®] versions.